



## MODIFICATION USER INSTRUCTIONS

ZTE MC801A 5G Router Modification Instructions:

### Warranty Notes:

- This modification voids all warranty rights with manufacturer and therefore shall not be returnable under warranty to the manufacturer.
- Do not open the unit once modified, doing so may damage the new antenna outputs. Any attempt to open the unit causing damage to the outputs are a chargeable repair.

### Antenna notes:

- Please note this modification has converted the internal antennas to external antennas.
- The internal antennas are no longer functional as they are now converted for external antenna use.

### 5G SA/NSA

- SA (Stand-Alone) means the mast and router are capable of negotiating a link without needing a 4G connection first, the router must be SA capable, and the mast must have its own dedicated 5G infrastructure "SA" not dependant on 4G.
- NSA (None Stand-Alone) means the router and the mast must negotiate a 4G link before it can establish its 5G link. Once connected to 5G it will still require the 4G link to maintain the 5G connection.

### Software Configuration:

- There has been No firmware/software adaptations to the router during the modification process.
- During testing of the modification, the router will have been restored to factory default setting, any setting that were previously on the unit have been lost.
- (if your unit has factory antenna outputs) Please ensure within the router login page, you have selected "use internal antenna" this ensure the use of the modified antenna outputs. (Some routers do not have this option available)

**Port Frequency band Ranges:** (please Refer to the routers specifications and you're local network band support list for compatibility)

### 4G Ports:

- Low Band – 700~900Mhz (Bands 8,20,19,6,5,18,26,27,14,13,17,28,68,12,85,,71,31,72,73,88,87,29,67)
- Mid Band – 901~2100Mhz (Bands 70,25,2,9,3,24,21,11,74,32,75,76)
- High Band – 2101~3500Mhz (Bands 22,7,15,16,69,30,23,66,65,1,10,4)
- 5G – 700~2900Mhz (Bands N1, N12,N2,N20,N25,N28,N3,N5,N50,N51,N65,N66,N7,N70,N71,N74,N8)

### 5G Ports:

- 5G – 3300~5000Mhz (N77,N78,N79)

**NOTE: Q4 2022 Models only have 3x 5G ports not 4 SMA Ports.**

This modification will allow the use of the new external inputs in any of the below configurations.

Contact Information

Email: [enquiries@router-mods.co.uk](mailto:enquiries@router-mods.co.uk)

Web: [www.router-mods.co.uk](http://www.router-mods.co.uk)



## MODIFICATION USER INSTRUCTIONS

### Full Mod - 5G NSA Configuration

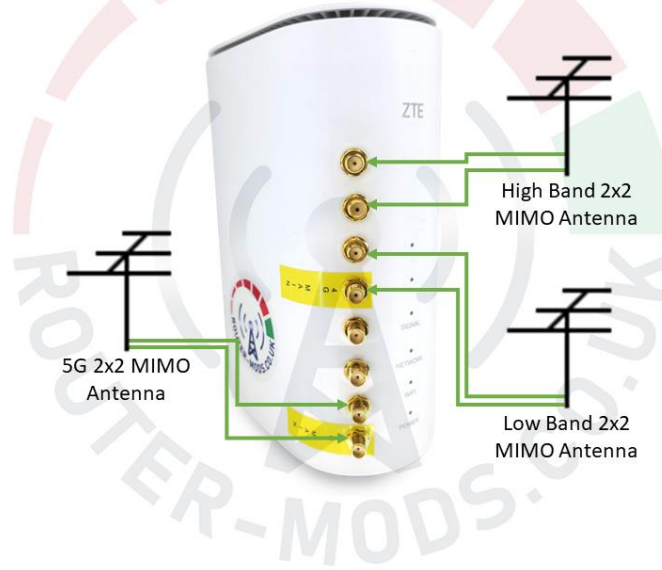

### Full Mod - 4G Configuration

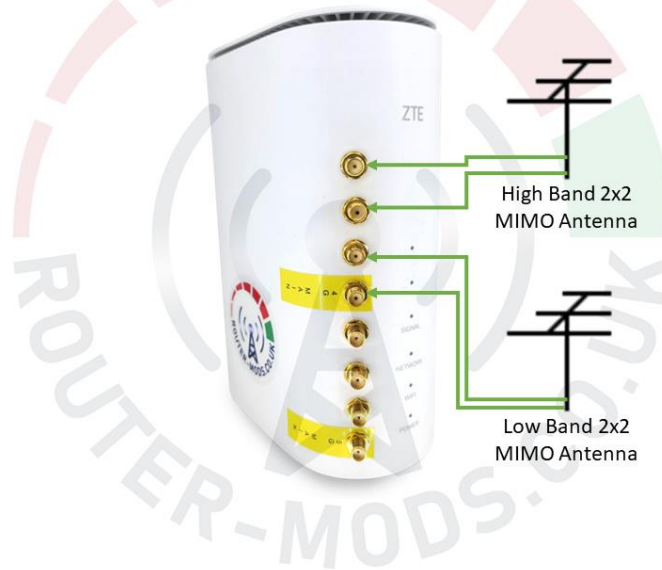

Contact Information

Email: [enquiries@router-mods.co.uk](mailto:enquiries@router-mods.co.uk)

Web: [www.router-mods.co.uk](http://www.router-mods.co.uk)



## MODIFICATION USER INSTRUCTIONS

### Full Mod - 5G SA Configuration

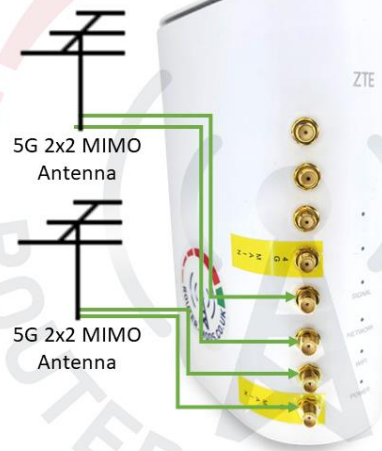

### Part Mod - 4G Configuration

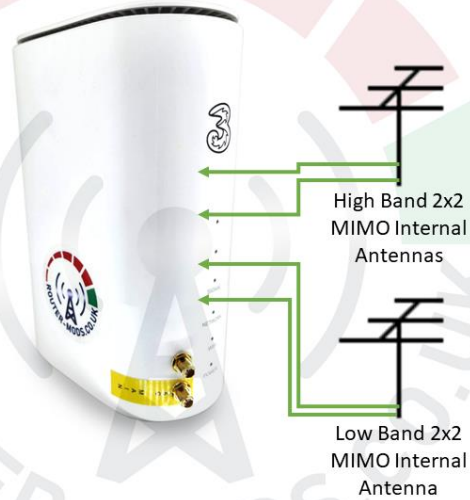

Contact Information

Email: [enquiries@router-mods.co.uk](mailto:enquiries@router-mods.co.uk)

Web: [www.router-mods.co.uk](http://www.router-mods.co.uk)



## MODIFICATION USER INSTRUCTIONS

### Part Mod - 5G SA Configuration

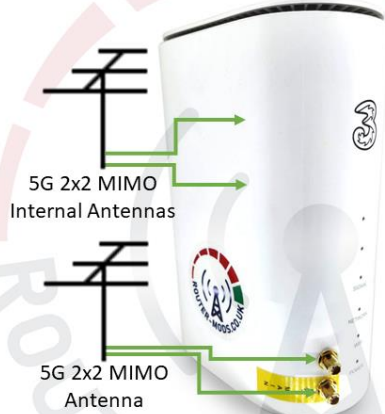

### Part Mod - 5G NSA Configuration

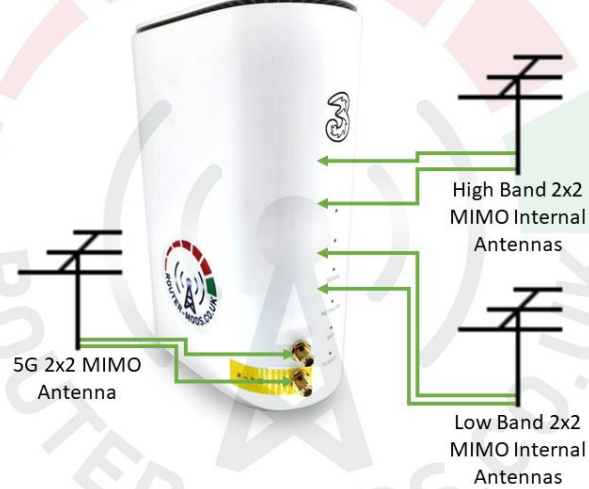

Contact Information

Email: [enquiries@router-mods.co.uk](mailto:enquiries@router-mods.co.uk)

Web: [www.router-mods.co.uk](http://www.router-mods.co.uk)



## MODIFICATION USER INSTRUCTIONS

**NOTE – Newer 2022 models have only 3x 5G ports**

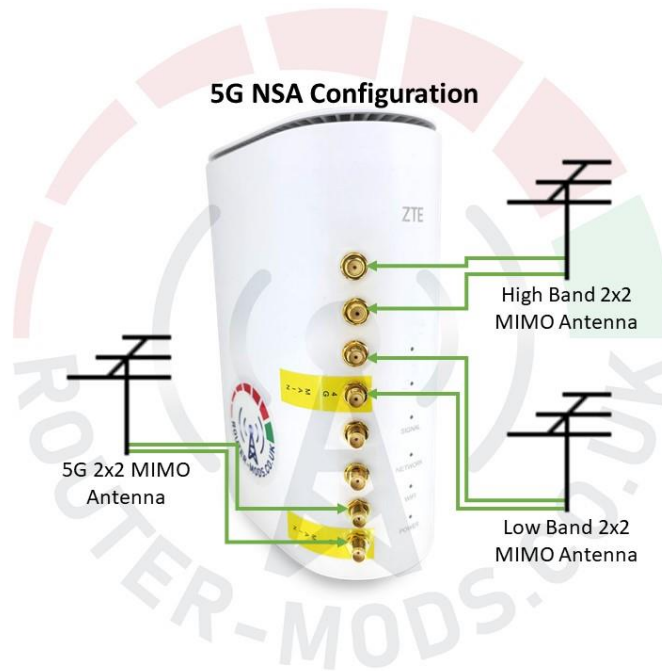

Contact Information

Email: [enquiries@router-mods.co.uk](mailto:enquiries@router-mods.co.uk)

Web: [www.router-mods.co.uk](http://www.router-mods.co.uk)



## MODIFICATION USER INSTRUCTIONS

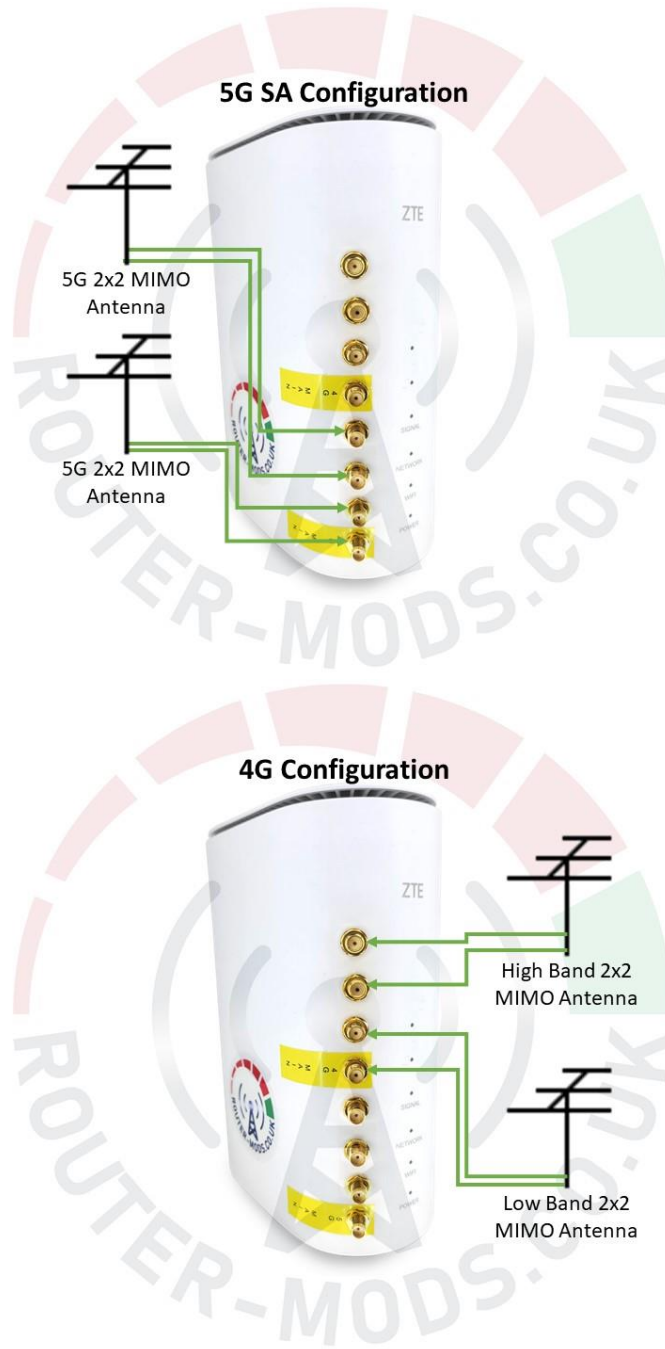

For any other enquiries please contact us.

Contact Information

Email: [enquiries@router-mods.co.uk](mailto:enquiries@router-mods.co.uk)

Web: [www.router-mods.co.uk](http://www.router-mods.co.uk)